

MV730 Quick Setup Guide

Learn how to set up your new Micodus Tracker

Copyright ©2020 MICODUS | All Rights Reserved

1. Product Parameter

Networks	GSM/GPRS
Frequency	850/900/1800/1900Mhz
Build-in Battery	Chargeable 3.7V 80mAh Polymer Li-Ion Battery
GPS Sensitivity	-159dBm
GPS Accuracy	5m
LBS Accuracy	100-2000m
Working Voltage	10-40V DC
GPS Start time	Cold start 45s / Warm start 35s / Hot start 1s
Dimension	31*31*57mm (L*W*H)
Weight	53g

2. Activate Device

Insert the **Nano** Spionlink SIM, which comes with the package. No need to set APN. Included 1MB free data for quick activated. No contracts or other fees.

If there's no SIM card in the package, please buy a SIM card that must support GSM&GPRS and with enough credit.

Send SMS to configure APN:

SMS Command Format	Reply	Example	Note
apn123456+space+apn name	apn ok	apn123456 cmnet	Please get the exact correct APN name from local SIM card provider, "cmnet" is just an example of APN name.
apnuser123456+space+apnuser	apnuser ok	apnuser123456 cmnet	If the SIM card operator doesn't have APN user name, then please ignore this configuration
apnpassword123456+space+apnpassword	apnpassword ok	apnpassword123456 123	

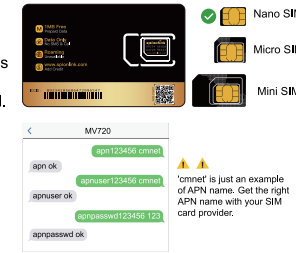

3. SIM Card Installation & Wiring

3.1 SIM card installation

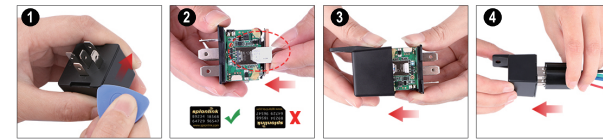

3.2 Where to place

Under Front Dash

Inside Door Pedal

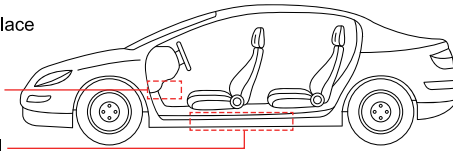

3.3 Wiring

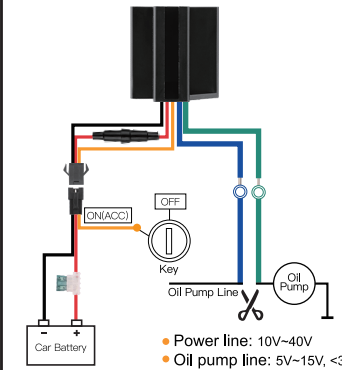

3.4 Installation video

<http://www.micodus.com/news/videos>

4. Turn on/off & Charge

- Turn on: Insert a SIM card into the MV730, it will turn on automatically.
- Turn off: Open the lid and take off the SIM card, it will turn off immediately.
- Charge: When installed into the car, it will be charging.

5. Install an App

Search "**MICODUS**" on APP Store or Google Play, or just scan the QR Code.



6. Sign in

6.1 If this is your first MICODUS Device, tap **IMEI/ID** to input or scan the IMEI or ID number on your device. The default password is **123456**.

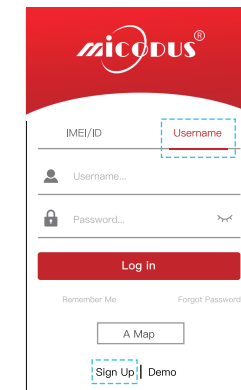
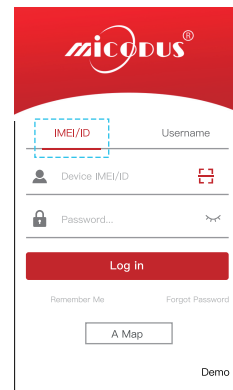

6.2 If you would like to add devices on one account, tap **Username** then tap **Sign Up**.

Take a few minutes to sign up:

- Fill in with your Email address
- Tap **Get verification code**, apply Verification Code
- Input the code, create your password (Ex: 2019GPStracker)

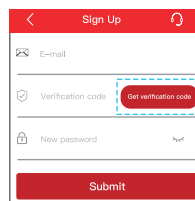

6.3 Tracking platform on Website: www.micodus.net

7. Start using your MICODUS Tracker

If you would like to learn more about the features, please open the APP to see the **User Guide**.

8. Any Questions?

E-mail: support@micodus.com
Skype: MICODUS

9. MV730 Full SMS Commands List

Functions	Command Format	Example
Set Admin Number	admin123456+space+mobile number with country code	admin123456 0086134*****
Back to Factory Setting	begin123456	begin123456
Password Change	password+old password+space+new password	password123456 654321
Restart	rst	
APN	apn+123456+apn content	apn123456 cmnet
	apnuser+123456+space+content	
	apnpassword+123456+space+content	
IP&Port	adminip+123456+space+ip+space+port	admin123456 47.254.77.28 7700
Domain	SZCS,123456.DOMAIN=d.micodus.net.7700	
Tow Truck Alarm	disable tow truck alarm: tow0	tow0
	SMS warning: tow1,+alarm distance(500-10000m)	tow1,300
	call warning: tow2,+alarm distance	tow2,300
	SMS+call warning: tow3,+alarm distance	tow3,300
	website warning: tow4,+alarm distance	tow4,300

ACC Auto Arm(on)	auto1	auto1
ACC Auto Arm(off)	auto0	auto0
ACC Auto Arm alarm time	accl,+alarm time(seconds)	accl,30
Google Maps Link	G123456# or where	
Data Upload Frequency	upload123456+space+time	upload123456 15
Time Zone	timezone+123456+space+GMT No.	timezone123456 -4
Parameter Query	param1	
	param2	
Status	status	
Arm	111 or SF	
Disarm	000 or CF	
Cut Off Fuel	555	
Resume Fuel	666	
Movement Alarm	move+alarm distance	move300
Overspeed Alarm	speed+123456+space+080(km/h)	speed123456 080
IMEI Checking	imei+123456	imei123456